

DESCRIPTION DOCUMENT FOR Retro to IIoT
HARDWARE REVISION 0.2

Department	Name	Signature	Date
Author			
Reviewer			
Approver			

Revision History

Rev	Description of Change	Effective Date
A	Initial Release	

ABSTRACT:

This document is a detailed product description that describes the effective features of the product. It includes a functional hardware description of the product with its internal block diagram and product images.



Table of Contents

Revision History	1
1. ABBREVIATIONS	4
2. REFERENCES	4
3. PURPOSE	4
4. SCOPE	4
5. SAFETY AND WARNING	4
6. PRODUCT FEATURES	5
7. PRODUCT DESCRIPTION	5
a. PHYSICAL DESCRIPTION	5
b. FUNCTIONAL DESCRIPTION	5
8. SYSTEM OVERVIEW	6
9. TECHNICAL SPECIFICATION	7
a. ELECTRICAL SPECIFICATION	7
b. MECHANICAL SPECIFICATION	7
10. ELECTRICAL CONNECTIONS	8
a. HEADER PIN CONFIGURATION	9
i. HEADER VDC_IN	9
b. BUTTONS AND LEDs	9
c. PROGRAMMING HEADER	10
d. PROGRAMMER CONNECTION DIAGRAM	10
11. COMMANDS FOR IOs	11
a. COMMANDS TO READ INPUT	11
b. COMMANDS TO CONTROL OUTPUTS	11
c. EXAMPLE MQTT COMMANDS TO CONTROL OUTPUTS	13
12. HOW TO USE THE DEVICE	14
a. STEPS TO CONFIGURE THE DEVICE TO NETWORK HOSTED BY YOU:	14
b. STEPS TO CONNECT SMARTPHONE TO MQTT BROKER:	18
c. STEPS TO TEST OUR <i>Retro to IIoT</i> DEVICE USING SMARTPHONE AND MQTT BROKER:	20
d. CONTROL OUTPUTS VIA SMARTPHONE:	22
e. READ DIGITAL INPUTS VIA SMARTPHONE	23
f. READ STATUS OF DIGITAL OUPUTS RANDOMLY VIA SMARTPHONE.	25
g. READ MAC ADDRESS OF CLIENT DEVICE VIA SMARTPHONE	27
IMPORTANT NOTICE	29

Table of figures

Figure 1: Block Diagram	5
Figure 2: Board Dimensions	8
Figure 3: Input / Output Details	8
Figure 4: Header Pin number references	9
Figure 5: Buttons and LEDs	9
Figure 6: Programming Header	10
Figure 7: Programmer Connection Diagram	10
Figure 8: subscription Topic from system for Digital Inputs.	11
Figure 9: subscription Topic from system for Digital Output	12
Figure 10: subscription Topic from system for Analog Input	12
Figure 11: Available Wifi networks searched	14
Figure 12: Smartphone Connected to Wifi hosted by DIO board	15
Figure 13: Default IP address entered in the Web browser	15
Figure 14: Accessed webpage of DIO module	16
Figure 15: Entered all the required details	16
Figure 16: Submitted the updates	17
Figure 17: Smartphone searched for available Wifi networks	18
Figure 18: Trying to connect to pre-configured MQTT broker	18
Figure 19: Smartphone connected to MQTT broker	19
Figure 20: MyMQTT app menu page	20
Figure 21: MQTT broker IP address and port number entered	20
Figure 22: Saved the settings	21
Figure 23 Entered topic and message to control outputs	22
Figure 24: Tapped on the home screen	23
Figure 25: Clicked on the Subscribe option	23
Figure 26: Entered the Subscription topic and clicked on the Add button	24
Figure 27: Dashboard window to monitor status of Digital Inputs	24
Figure 28: Opened Publish option	25
Figure 29: Entered topic and message to be published to read the current status of Digital Outputs	25
Figure 30: Reading status of Outputs on Dashboard screen	26
Figure 31: Opened Publish option	27
Figure 32: Entered topic and message to be Published to read the MAC address of the device	27
Figure 33: Message Published	28
Figure 34: Reading MAC address on Dashboard screen	28

1. ABBREVIATIONS

Term	Description
HTTP	Hypertext Transfer Protocol
MQTT	Message Queue Telemetry Transport
PLC	Programmable Logic Control
DC	Direct Current
GND	Ground (DC)
IIoT	Industrial Internet of Things
DI	Digital Input
DO	Digital Output
AI	Analog Input
CAN	Control Area Network
TCP	Transmission Control Protocol

2. REFERENCES

Company Website link	https://www.armtronix.in
Instructable's Weblink	-
Github's Weblink	-
Youtube Weblink	-

3. PURPOSE

The purpose of this document is to outline the design description for the Retro to IIoT. It provides a high-level summary of the product.

4. SCOPE

This document describes system architecture which includes Digital Inputs, Digital Outputs, Analog Inputs, Ethernet, WiFi Module and Power Supply.

5. SAFETY AND WARNING

If you are working with DC power, please take necessary precautions. Do not short the positive and negative terminals of the power supply, as it may damage the Hardware and may create hazardous to your health. Do not bring AC power in contact with this board, which will damage the hardware and may create hazardous to your health. Please consider disconnecting power supply from the board if you would like to make any changes in connections. Working without safety towards hardware is not advisable. Electronic devices are static sensitive and suggest you to take necessary steps towards antistatic measures.

Fire Hazard: Making wrong connections, drawing more than rated power, contact with water or other conducting material, and other types of misuse/overuse/malfunction can all cause overheating and risk starting a fire. Test your circuit and the environment in which it is deployed thoroughly before leaving it switched on and unsupervised. Always follow all fire safety precautions.

6. PRODUCT FEATURES

- Works directly with Industrial standard DC power 12-24V.
- Three isolated Digital Input, three isolated digital output and Four analog inputs are available to user.
- Both input and output are 12-24V voltage level compatible.
- WiFi with MQTT protocol compatible.
- The MQTT commands are given in this document to control and monitor inputs and outputs.
- Basic Firmware to enter SSID and password to connect to the router and testing. **(NOT FOR ANY SPECIFIC APPLICATION)**
- Configuration and Reset push button available.

7. PRODUCT DESCRIPTION

a. PHYSICAL DESCRIPTION

- Wifi Module
- Ethernet
- CAN bus – Control Area Network
- RS485 / Modbus
- Analog Inputs (4 – 20 mA) – 4 numbers
- Isolated Digital Inputs – 3 numbers
- Isolated Digital Outputs – 3 numbers
- DC to DC Power supply module

b. FUNCTIONAL DESCRIPTION

Block Diagram

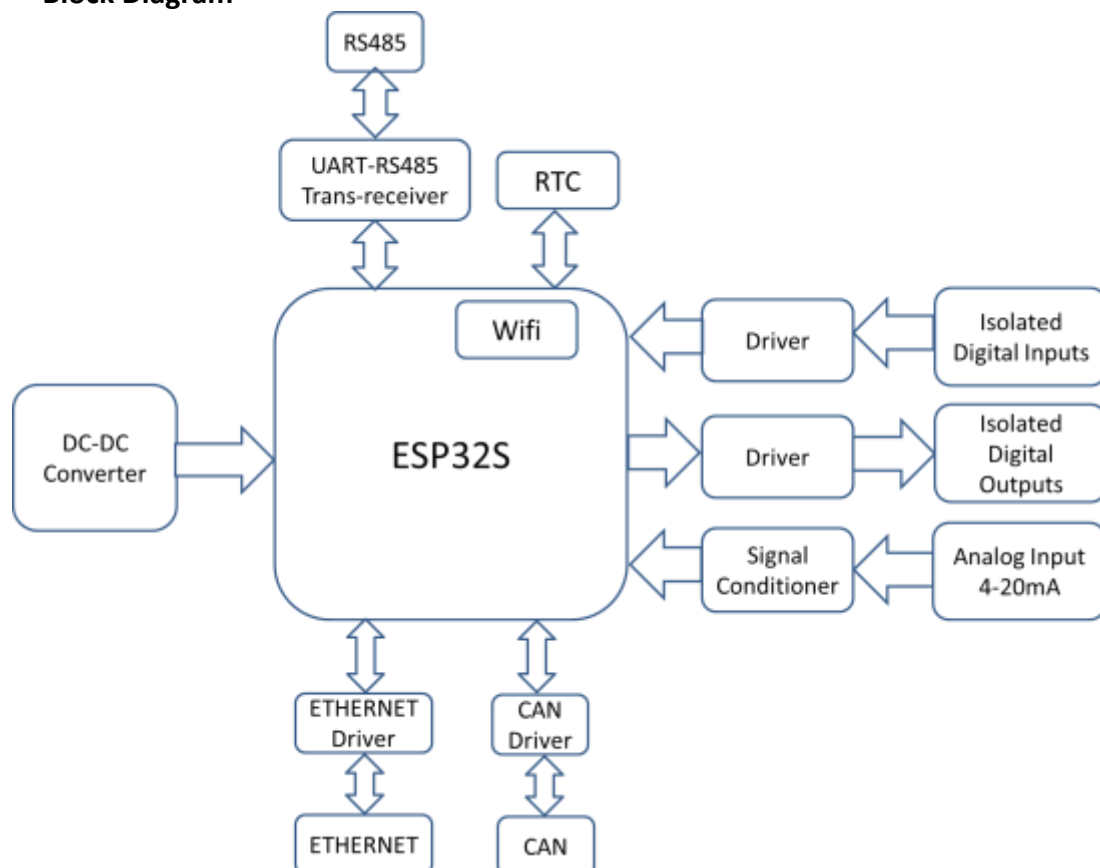

Figure 1: Block Diagram

Retro to IIoT is designed and developed for industrial automation application to solve the problem of laying cables for remote monitoring and control. The device will be operated with industry standard 24V DC power input. The device has features like, Wifi, Ethernet, CAN, RS485, Analog inputs, Digital inputs and Digital outputs. The digital inputs and outputs are optically isolated to monitor sensors Ex: proximity switch and control (ON/OFF) external electrical DC loads like Lamps, relays respectively via available mode of communications like CAN or ethernet or Wifi or Modbus TCP. The device can be interfaced with PLC and/or MQTT broker or Wifi Access point.

8. SYSTEM OVERVIEW

1. DC to DC Power supply module

The DC-DC converter on board is used to regulate voltage from 24 V DC to 3.3 V DC to supply power to complete digital part including Wifi module.

The main power input 24V supply is also used to provide limited power to isolated outputs.

2. Wifi Module

Wifi module used in the device is ESP32 as it compatible with Arduino IDE for ease of programming. with all its required GPIOs are easily accessible to user for their own application. Wifi module is powered on through on-board regulated 3.3 V DC. User can program this device for their application to work on either on MQTT / HTTP mode of protocol.

3. Ethernet:

Ethernet MAC interface with dedicated DMA and IEEE 1588 Precision Time Protocol support. commonly used in local area networks. This device has dedicated RJ45 jack for ethernet based operations. User can program this ethernet port for required protocols like Ethernet, TCP, Modbus TCP etc..

4. CAN bus

CAN is full formed as Control Area Network a bus network allows user to communicate with neighboring devices via stable network and with negligible data loss. The speed of the transition is faster when a recessive to dominant transition occurs since the CAN wires are being actively driven. The speed of the dominant to recessive transition depends primarily on the length of the CAN network and the capacitance of the wire used.

5. Isolated Digital Inputs – 3 Numbers

There are twelve numbers of optically isolated inputs given accessible to user to monitor sensors or read any digital inputs with voltage level between 12V DC – 24V DC. The optical isolation is used to protect the hardware from any electrical hazardous at/from external interfaces to the board like sensor or any other respective inputs.

6. Isolated Digital outputs – 3 Numbers

There are twelve numbers of optically isolated outputs given accessible to user to control low power consumption loads with voltage level between 12V DC – 24V DC. The optical isolation is used to protect the hardware from any electrical hazardous at/from external interfaces to the board like solenoids, relays or any other respective outputs.

7. Analog Inputs – 3 Numbers:

As mentioned above, this board also supports for Analog input measurement for monitoring sensors with analog output from 4-20mA DC. The ADC used in this board is ADS1115 from Texas Instruments. Communication between Pi and this ADC is I2C. AIN0 ADC is used for Li-Po battery voltage monitoring purpose. Remaining 3 AINs are given access user to read 4-20mA DC current input. For more information on this ADC, please refer to it technical datasheet from its manufacturer at <http://www.ti.com/lit/ds/symlink/ads1115.pdf>

8. Real Time Clock.

Real Time Clock on this board is DS1307 from Maxim Semiconductor. Communication between Pi and this RTC is I2C. CR1220 button cell holder is given on the board for ease of installation of RTC battery. For more information on this RTC, please refer to it technical datasheet from its manufacturer at <https://datasheets.maximintegrated.com/en/ds/DS1307.pdf>.

9. TECHNICAL SPECIFICATION

a. ELECTRICAL SPECIFICATION

Input Specifications				
Description	Min	Typ	Max	Unit
Voltage DC	12	24	24	Volts
Current DC	-	1	-	Amps
Power DC	-	24	-	Watts

Isolated Digital Outputs Specifications (Maximum)				
Description	Min	Typ	Max	Unit
Voltage DC	-	-	24	Volts
Current DC	-	-	0.3	Amps
Power DC	-	-	0.72	Watts

Isolated Digital Inputs Specifications (Maximum)				
Description	Min	Typ	Max	Unit
Voltage DC	-	-	24	Volts
Current DC	-	-	0.03	Amps

Analog Inputs Specifications (Maximum)				
Description	Min	Typ	Max	Unit
Current DC	4	-	20	Milli Amps

b. MECHANICAL SPECIFICATION

- Mechanical Dimensions of PCB are 130 x 70 x 74 mm (Length x Width x Height)
- For more details on dimension of the board, please refer to Figure 2.

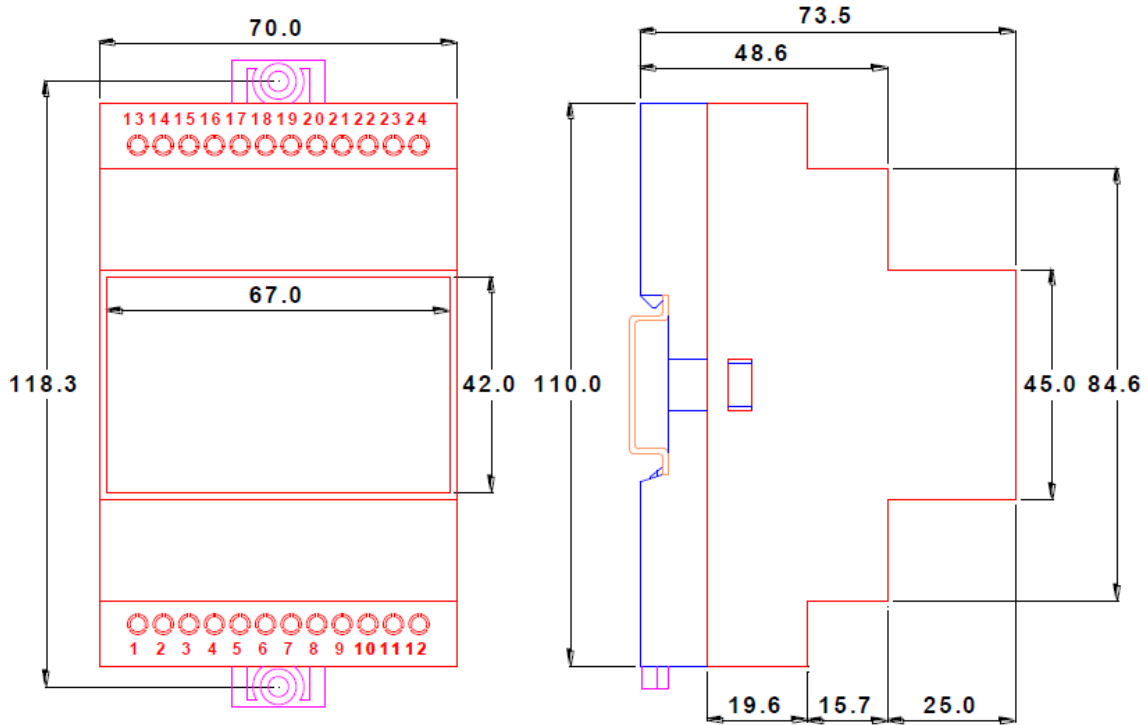

Figure 2: Board Dimensions

10. ELECTRICAL CONNECTIONS

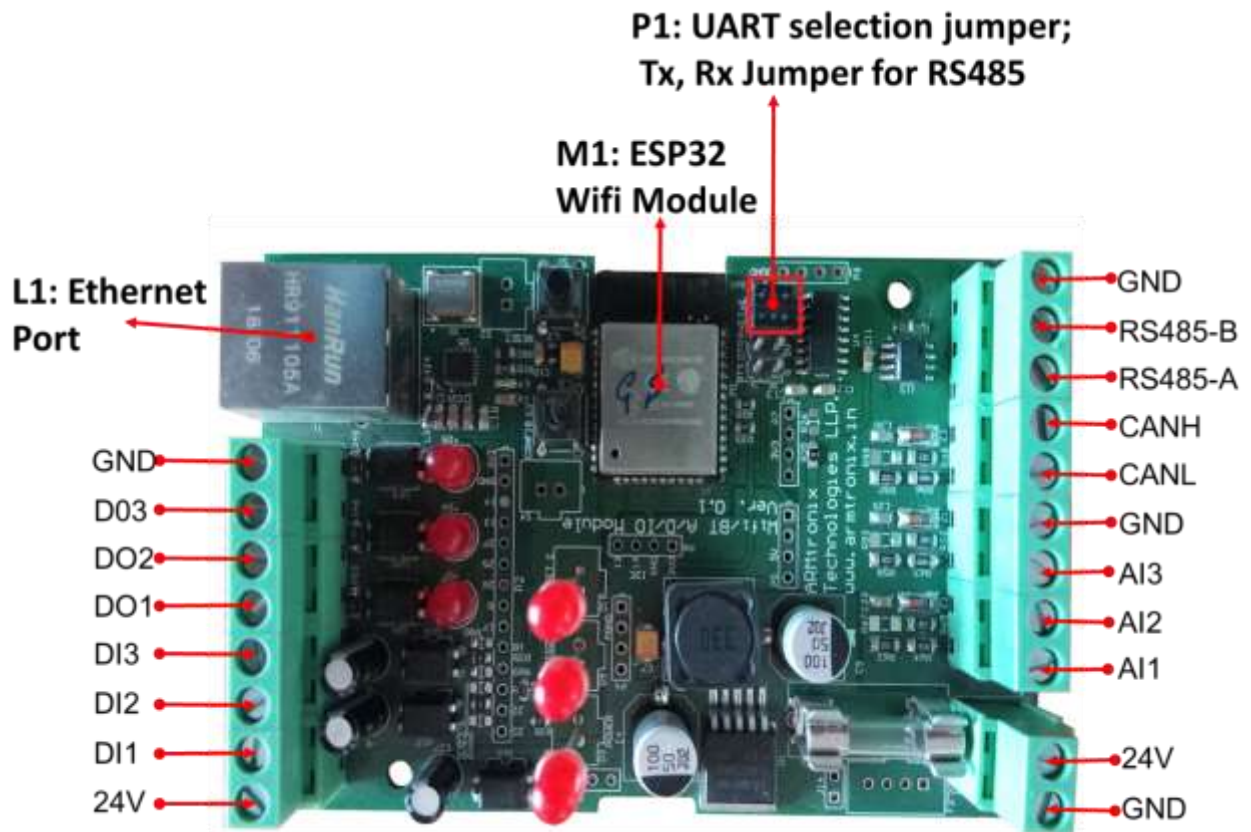

Figure 3: Input / Output Details

Description of Header and Switches shown in Figure 3:

	Designation	Description	ESP32 GPIO #
1.	VDC_IN	DC 24V power input	
2.	S1	Configuration Button	
3.	S3	RESET Button	
4.	D3	Power Presence indication LED	
5.	DI1	Digital input – 1	GPIO32
6.	DI2	Digital input – 2	GPIO33
7.	DI3	Digital input – 3	GPIO15
8.	DO1	Digital Output – 1	GPIO14 / GPIO17
9.	DO2	Digital Output – 2	GPIO13 / GPIO16
10.	DO3	Digital Output – 3	GPIO35
11.	AI1	Analog Input – 4	ADC39
12.	AI2	Analog Input – 5	ADC36
13.	AI3	Analog Input – 6	ADC34
14.	CANL	CAN port Low	
15.	CANH	CAN port High	
16.	A	RS485 Transmitter	
17.	B	RS485 receiver	

Figure 4: Header Pin number references

a. HEADER PIN CONFIGURATION

i. HEADER VDC_IN

Header Pin Number	Pin Name
1	GND
2	24 V DC (IN)

Table 1: Header VDC_IN Pin Configuration

b. BUTTONS AND LEDs

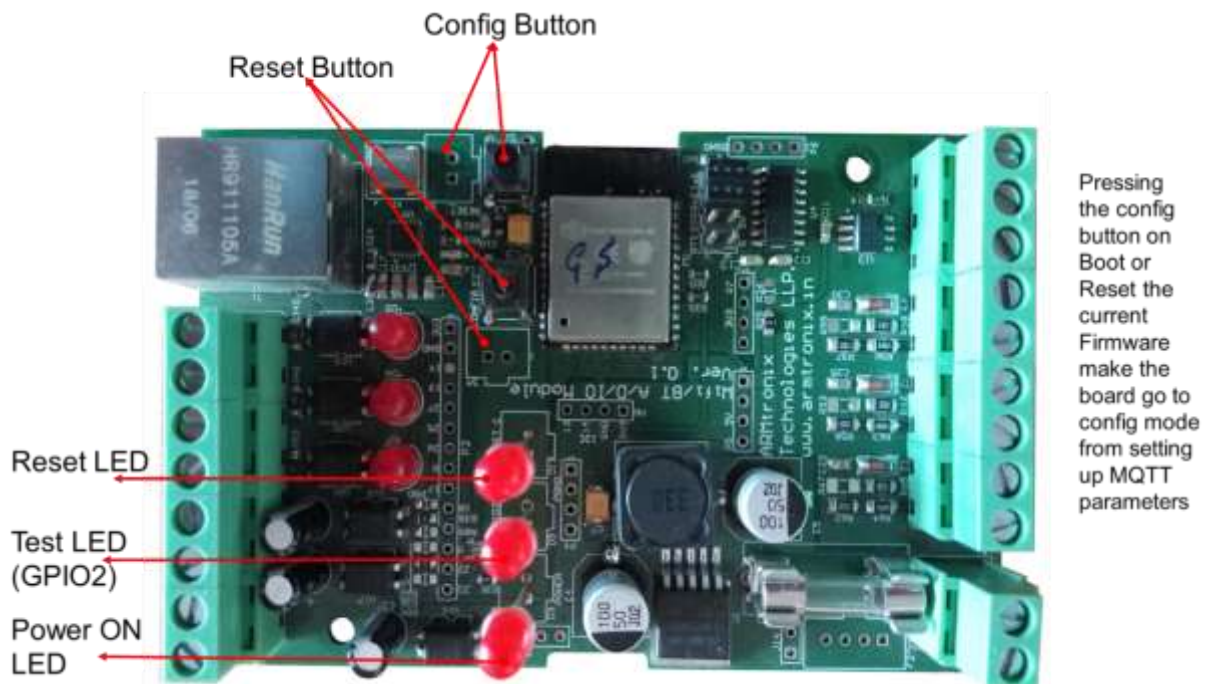

Figure 5: Buttons and LEDs

c. PROGRAMMING HEADER

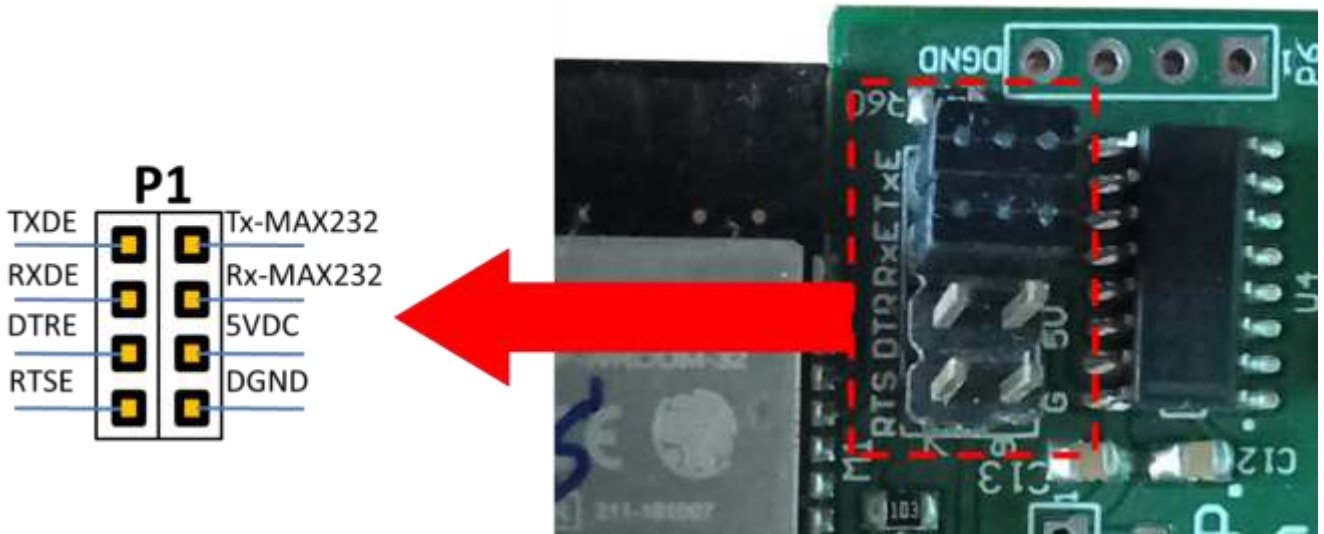

Figure 6: Programming Header

d. PROGRAMMER CONNECTION DIAGRAM

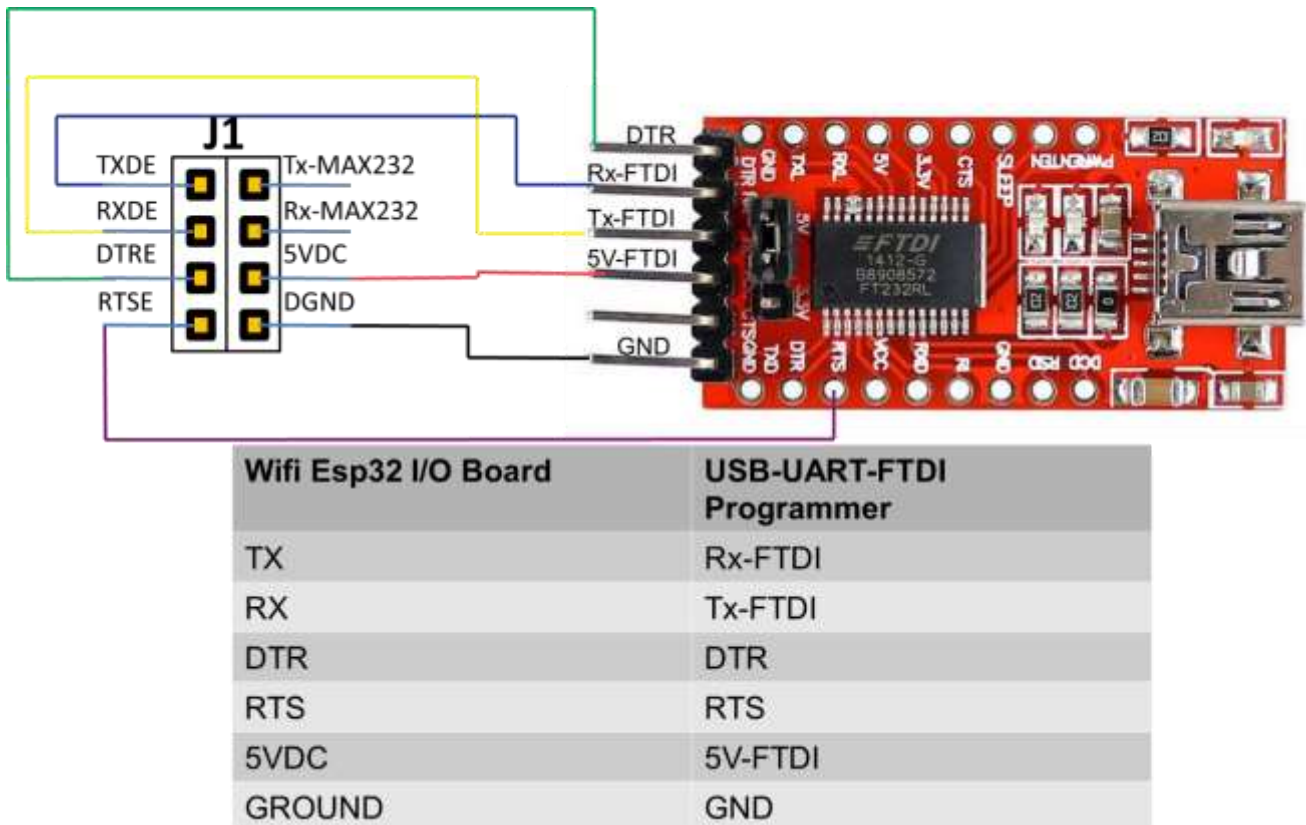

Figure 7: Programmer Connection Diagram

11. COMMANDS FOR IOs

Publishing Topic to read Inputs

Example: /I/00y

Subscription Topic to control outputs

Example: /O/00y

a. COMMANDS TO READ INPUT

- Generally on change in status of input or sensors on the topic will relevant information. This can be captured by any system which has subscribed to topic which the sensor board Publish's ON.
From the above ex. /I/00y is our boards publishing topic, so if any system subscribes to this, it will receive the information on change in status.

b. COMMANDS TO CONTROL OUTPUTS

- DIGITAL OUTPUT – ex. /O/00y_001; Topic publish from system.
Where, y is client number

DOx:

0	0	0
DO1	DO2	DO3

Where, 'x' is IO number

- *Read DIGITAL INPUT – ex. status_ip; subscription Topic from system.

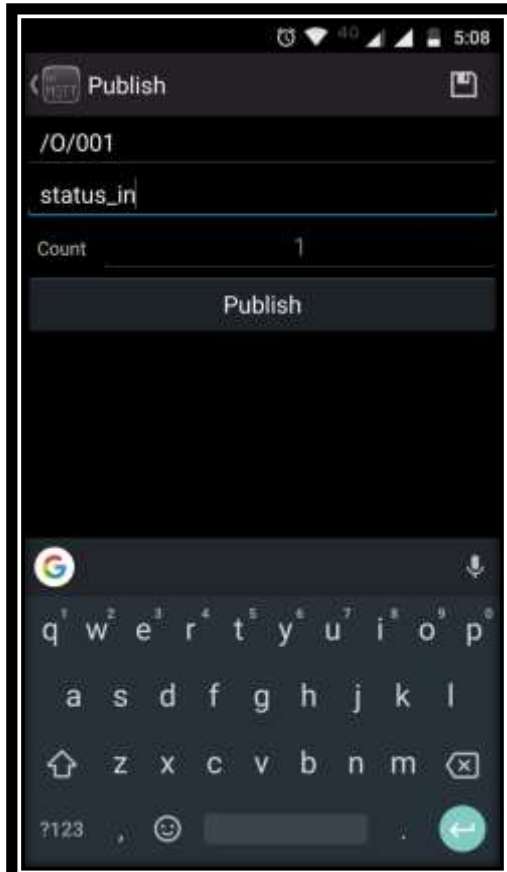

Figure 8: subscription Topic from system for Digital Inputs.

- *Read DIGITAL OUTPUT – ex. status_op; subscription Topic from system.

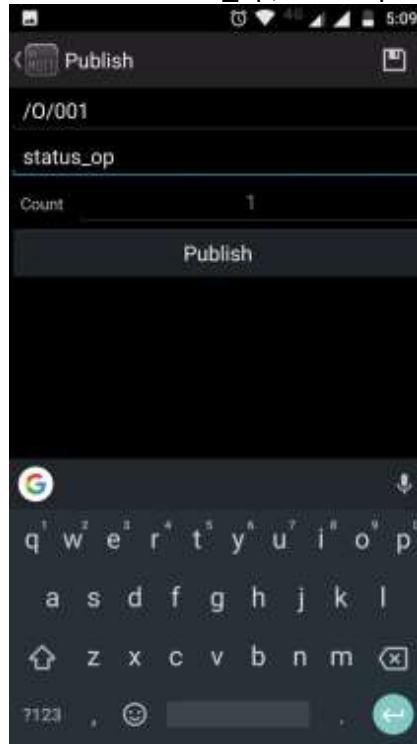

Figure 9: subscription Topic from system for Digital Output.

- *Read ANALOG INPIUT -- ex. status_an; Subscription Topic from system.

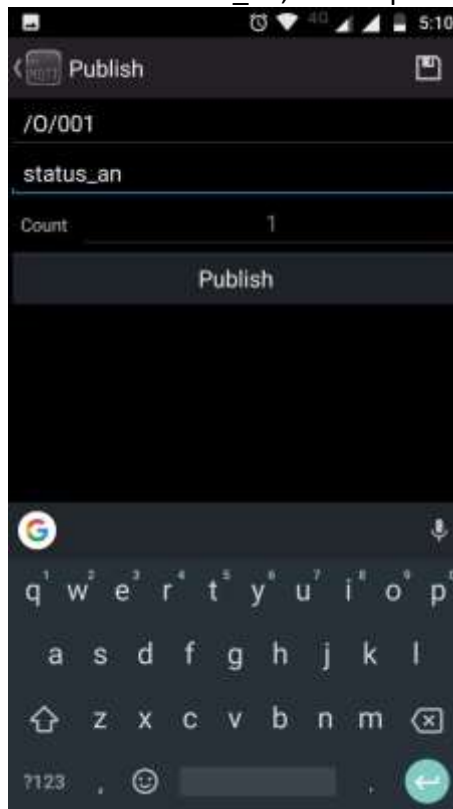

Figure 10: subscription Topic from system for Analog Input.

*Note: you can read all inputs using single command at an instant.

c. EXAMPLE MQTT COMMANDS TO CONTROL OUTPUTS

- DO1 - /O/00y_100; To turn ON only 1st output
- DO2 - /O/00y_010; To turn ON only 2nd output
- DO3 - /O/00y_001; To turn ON only 3rd output

- DI1 - /O/00y_100; To read status of 1st Digital Input
- DI2 - /O/00x_010; To read status of 2st Digital Input
- DI3 - /O/00y_001; To read status of 3st Digital Input

- AI1 - /O/00y_100; To read status of 1st Analog Input
- AI2 - /O/00y_010; To read status of 2nd Analog Input
- AI3 - /O/00y_001; To read status of 3rd Analog Input

12. HOW TO USE THE DEVICE

a. STEPS TO CONFIGURE THE DEVICE TO NETWORK HOSTED BY YOU:

- i. Switch ON the device.
- ii. Make sure that Power presence indication **Red LED** is glowing.
- iii. Wait till the Wifi Status indication LED starts blinking continuously **Green/Red** in color with duration of ~5 seconds, this indicates the device is NOT configured to any network.
- iv. Press the **config** button, wait till blinking of dual color LED to turns OFF. This indicate that the device is healthy and not previously configured to any network.
- v. To configure the device, Press and hold the **Reset** button and then press and hold the **Config** Button.
- vi. Now release only the **Reset** button, wait for 30 seconds, then release the **Config** button. Now the device will host its own network (Access point/Hotspot) to allow users to configure it.
- vii. Take any Smartphone.
- viii. Switch ON Wifi in it. (make sure that, its Mobile Data connection is turned OFF).
- ix. Search for available Wifi networks in the range

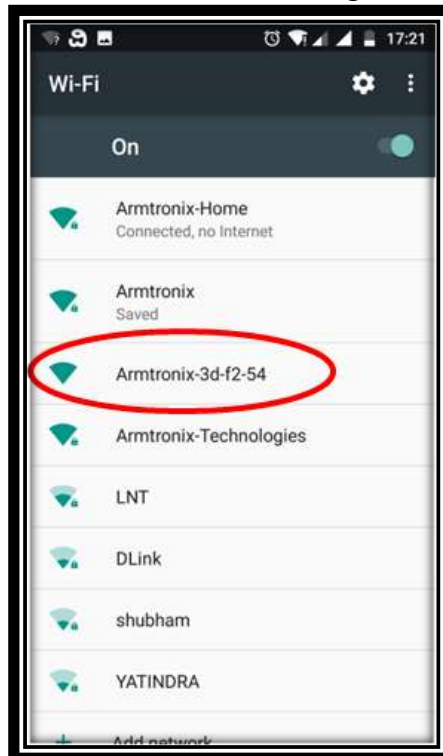

Figure 11: Available Wifi networks searched

- x. You will observe one of the available Wifi network as “Armtronix-xx-xx-xx”. Where xx: is last 6 digits of MAC address of the particular device. Click on that particular available network connect your smart phone to it. So in this scenario, the device is ‘Wifi Host’ and Smartphone is ‘Wifi Client’.

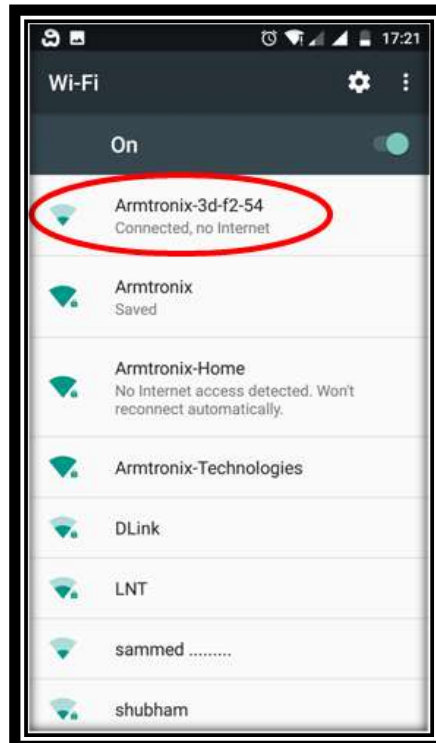

Figure 12: Smartphone Connected to Wifi hosted by DIO board

- xi. Open any web browser, enter default IP address 192.168.4.1 of the device when it is hosting its own Wifi network and click enter.



Figure 13: Default IP address entered in the Web browser

- xii. Clicking on Enter button after entering default IP address, you will be able to access its webpage as shown in Figure 9.

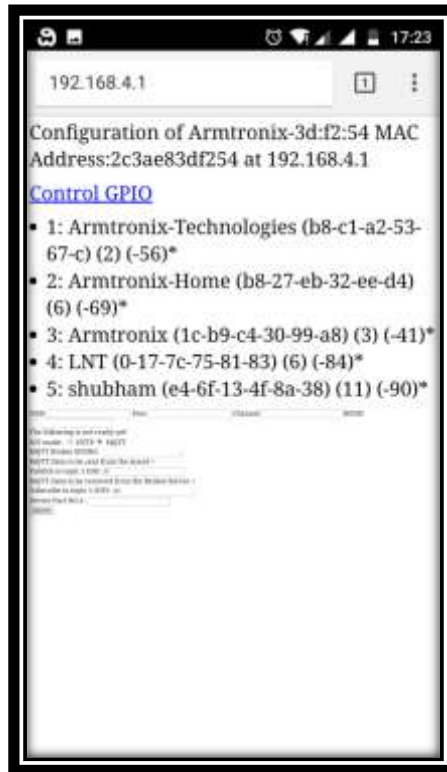

Figure 14: Accessed webpage of DIO module

- xiii. In the accessed webpage, fill-in all the required details like:
- **SSID** : SSID of Access Point
 - **Pass** : Password of Access point
 - **Channel** : Channel of Access point
 - **BSSID** : BSSID (MAC Add) of Access Point
 - **IOT Mode** : MQTT
 - **MQTT Broker IP/DNS** : xxx.xxx.xxx.xxx (Ex. 192.168.0.1)
 - **Publish to Topic 1 (IN)** : /I/xxx (Ex. /I/001)
 - **Subscribe to topic 1 (OP)** : /O/xxx(Ex. /O/001)
 - **Device Part NO.1** : xxx (Ex. 001)



Figure 15: Entered all the required details

- xiv. After entering all the required details, click on Submit button. It will save the parameters you entered and reboot the device and acknowledge the user in the webpage. Do not turn OFF the device, it will automatically reboot.



Figure 16: Submitted the updates

b. STEPS TO CONNECT SMARTPHONE TO MQTT BROKER:

- i. Disconnect Smartphone from any other Wifi network if connected.
- ii. Search for available Wifi network where the MQTT broker is running.
In our case it is “Armtronix-Home” is the wifi network where our MQTT broker is running.

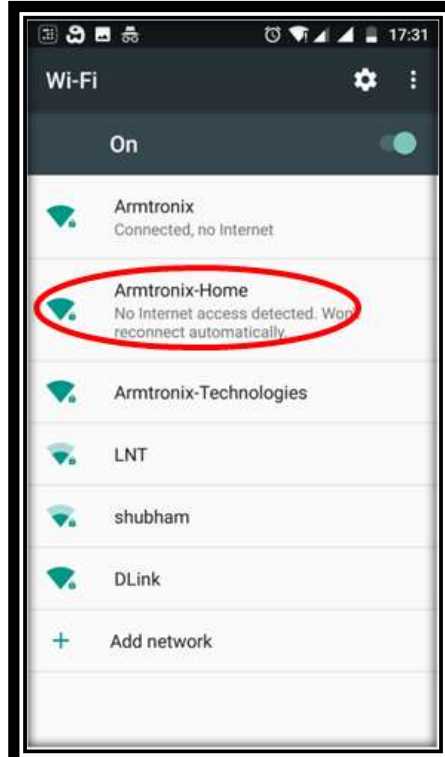

Figure 17: Smartphone searched for available Wifi networks

- iii. Click on that particular available network to connect your smart phone to it.

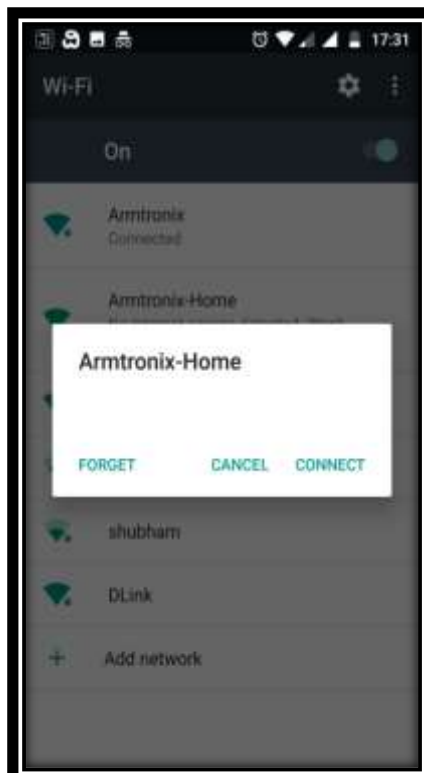

Figure 18: Trying to connect to pre-configured MQTT broker

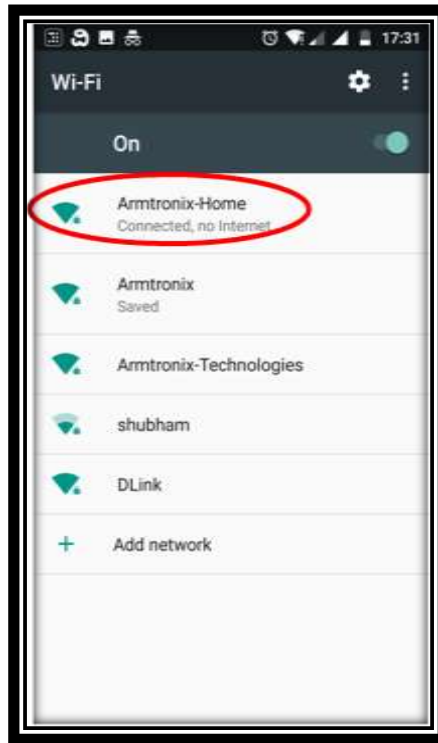

Figure 19: Smartphone connected to MQTT broker

c. STEPS TO TEST OUR *Retro to IIoT* DEVICE USING SMARTPHONE AND MQTT BROKER:

- i. Install 'MyMQTT' Android app in to a Smartphone you would use for testing.
- ii. Open an app 'MyMQTT' app Smartphone.

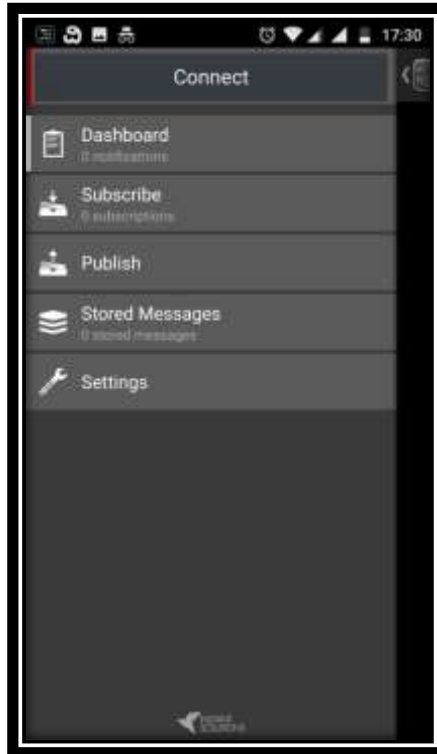

Figure 20: MyMQTT app menu page

- iii. Click on settings option.
- iv. Enter MQTT broker IP address and default Port number as 1883 (if not changed)
Our MQTT broker IP address is 192.168.0.1



Figure 21: MQTT broker IP address and port number entered

- v. On the completion of your IP address and port number entry, Save the settings by clicking on **Save** button. Popup will indicate once the settings saved.



Figure 22: Saved the settings

d. CONTROL OUTPUTS VIA SMARTPHONE:

- i. Connect Smartphone to network hosted having MQTT broker as said in section 12.b.
- ii. Open MyMQTT app in Smartphone.
- iii. Tap on the screen, it will open menu window.
- iv. Click on the Publish option.
- v. Enter topic as `"/O/00y"` where x is client device number entered while configuring.
- vi. Ex. Message `"/O/00y_111"` (Device will turn output 1 – output 3 as ON).

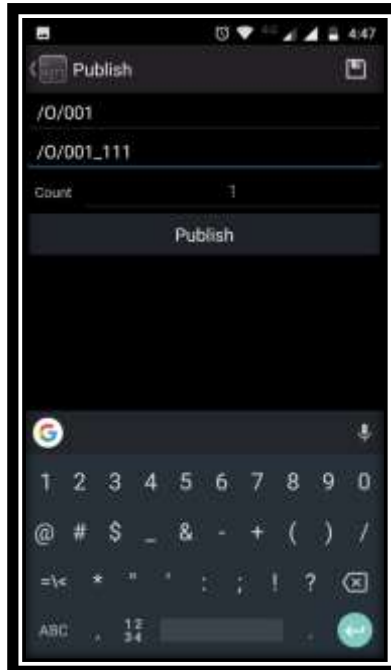

Figure 23 Entered topic and message to control outputs

- vii. Click on Publish button to publish the topic.
- viii. On publishing the topic, popup will arrive as *'Message Published'* the device will take action on the outputs.

e. READ DIGITAL INPUTS VIA SMARTPHONE.

- i. Connect Smartphone to network hosted having MQTT Broker as said in section 12.b.
- ii. Open MyMQTT app in Smartphone.
- iii. Tap on the screen, it will open menu window.

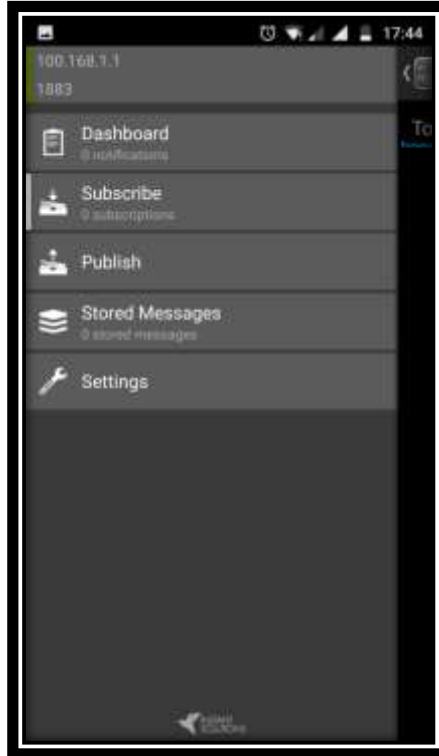

Figure 24: Tapped on the home screen

- iv. Click on the Subscribe option.



Figure 25: Clicked on the Subscribe option

- v. Enter topic as “/I/00x”; where x is client device number entered while configuring.
- vi. Click on Add button on the screen to subscribe to the topic. If you add ‘+’, all the messages under “/I/” will be received and displayed on Dashboard screen.

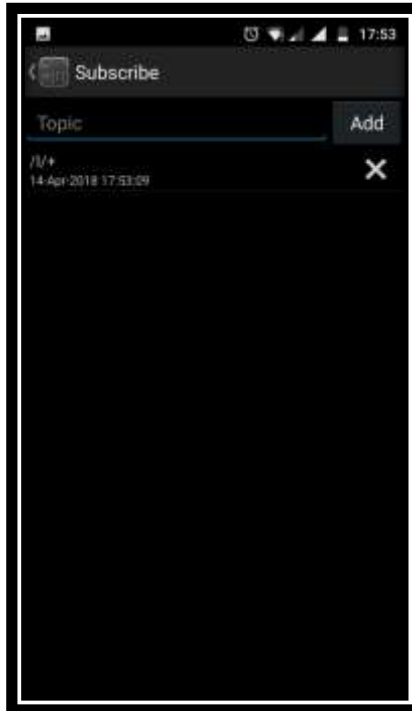

Figure 26: Entered the Subscription topic and clicked on the Add button

- vii. Click on back button located at left-top-corner of the screen.
- viii. Tap on the screen. It will open the menu.
- ix. Open the dashboard by clicking on Dashboard option in the menu.

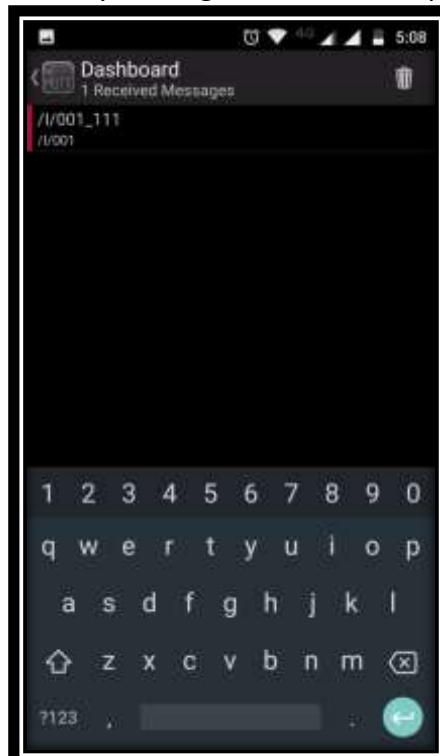

Figure 27: Dashboard window to monitor status of Digital Inputs

- x. You will receive the status of Inputs, as and when there is a change in status.

f. READ STATUS OF DIGITAL OUPUTS RANDOMLY VIA SMARTPHONE.

- i. Follow steps from 12.b.i to 12.b.viii
- ii. Click on the publish option.

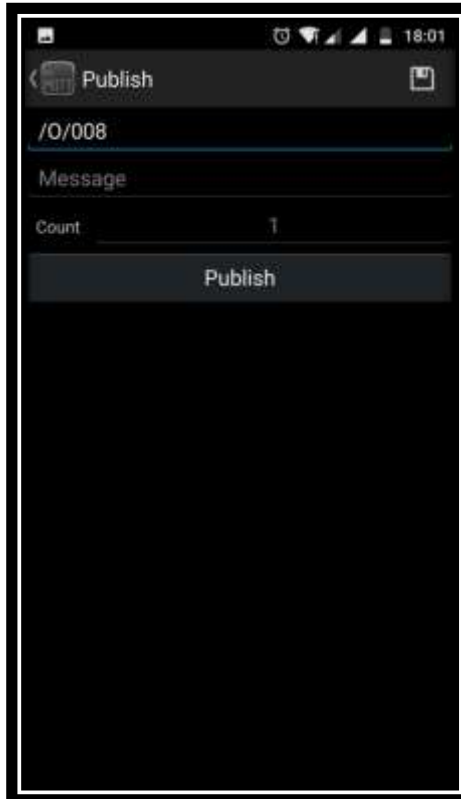

Figure 28: Opened Publish option

- iii. Enter topic as /O/001 status_op: (To read status of outputs)

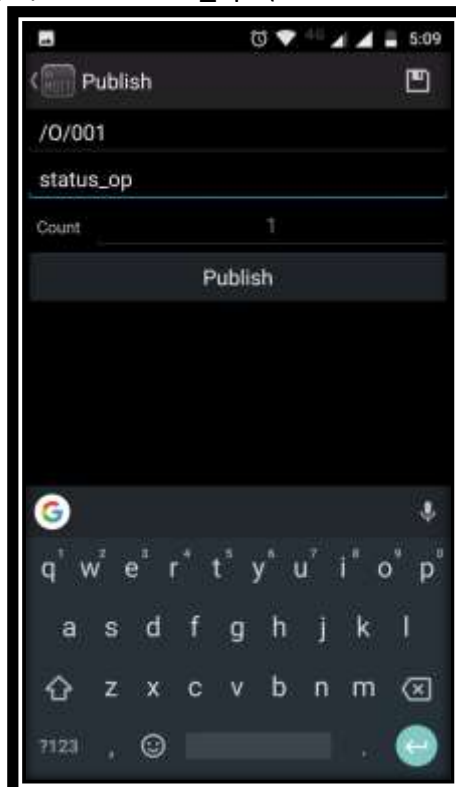

Figure 29: Entered topic and message to be published to read the current status of Digital Outputs

- iv. Click on publish button to publish the topic, you will get popup as *'Message Published'*
- v. Click on back button located at left-top-corner of the screen.
- vi. Tap on the screen. It will open the menu.
- vii. Open the dashboard by clicking on Dashboard option in the menu.
- viii. You will receive the current status of Outputs.



Figure 30: Reading status of Outputs on Dashboard screen

g. READ MAC ADDRESS OF CLIENT DEVICE VIA SMARTPHONE.

- i. Follow steps from 12.b.i to 12.b.viii
- ii. Click on the publish option.

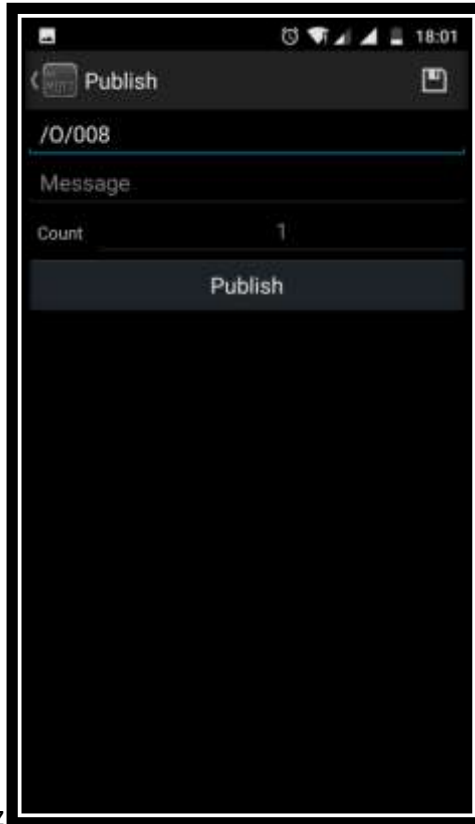

Figure 31: Opened Publish option

- iii. Enter topic as /O/00xMAC? (To read MAC address)

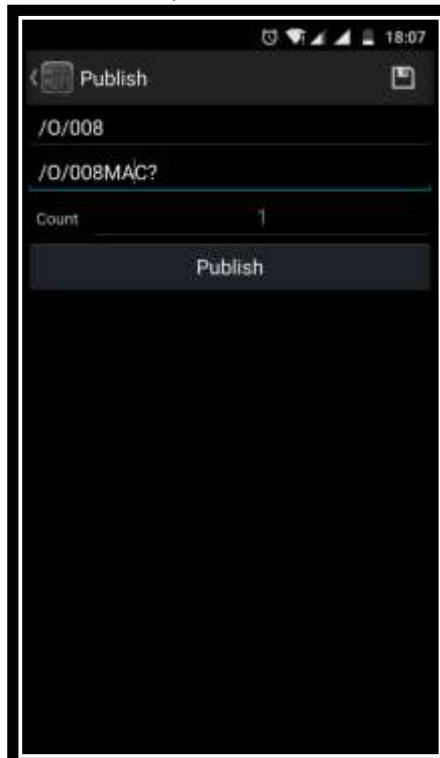

Figure 32: Entered topic and message to be Published to read the MAC address of the device

- iv. Click on publish button to publish the topic, you will get popup as *'Message Published'*

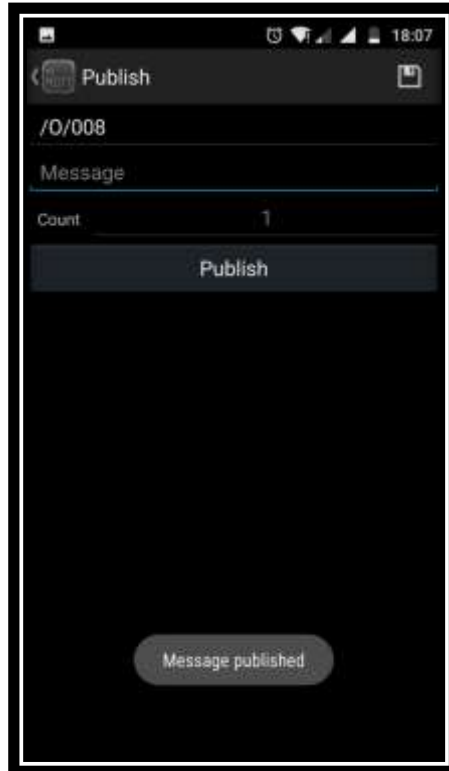

Figure 33: Message Published

- v. Click on back button located at left-top-corner of the screen.
- vi. Tap on the screen. It will open the menu.
- vii. Open the dashboard by clicking on Dashboard option in the menu.
- viii. You will receive the MAC address of the client without ":" or "-".

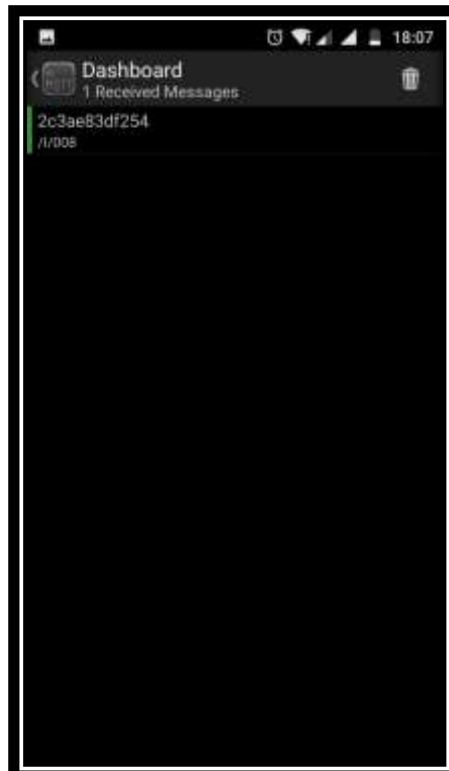

Figure 34: Reading MAC address on Dashboard screen



DOCUMENT #: IA015

DOCUMENT REV: B

DOCUMENT NAME: DESIGN DESCRIPTION, Retro to IIoT.

IMPORTANT NOTICE

ARMtronix Technologies LLP and its subsidiaries reserve the right to make corrections, enhancements, improvements and other changes to its products, services and documents and to discontinue any product or service. Buyers should obtain the latest relevant information before placing orders and should verify that such information is current and complete. All products are sold subject to ARMtronix Technologies LLPs terms and conditions of sale supplied at the time of order acknowledgment.

The information in this document is subject to update without notice. The contents of this document thereof must not be used for any unauthorized purpose.

-----END OF DOCUMENT-----